

NURSING CURRICULUM MAP 2015

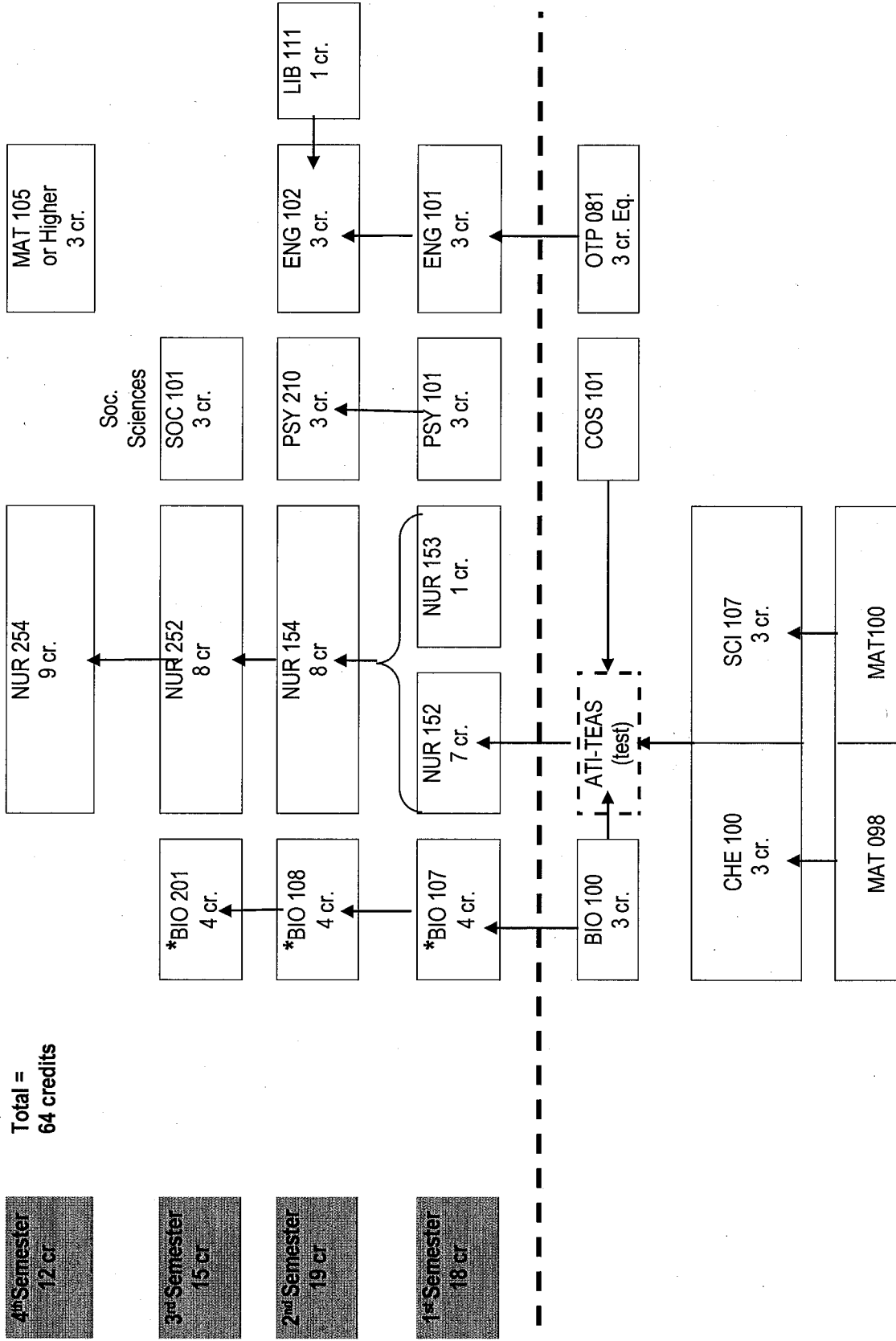

Name: _____ Advisor: _____ Date: _____